



Cambridge IGCSE™

CANDIDATE
NAME

CENTRE
NUMBER

--	--	--	--	--

CANDIDATE
NUMBER

--	--	--	--

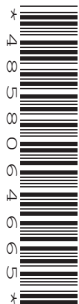

PHYSICS

0625/61

Paper 6 Alternative to Practical

October/November 2022

1 hour

You must answer on the question paper.

No additional materials are needed.

INSTRUCTIONS

- Answer **all** questions.
- Use a black or dark blue pen. You may use an HB pencil for any diagrams or graphs.
- Write your name, centre number and candidate number in the boxes at the top of the page.
- Write your answer to each question in the space provided.
- Do **not** use an erasable pen or correction fluid.
- Do **not** write on any bar codes.
- You may use a calculator.
- You should show all your working and use appropriate units.

INFORMATION

- The total mark for this paper is 40.
- The number of marks for each question or part question is shown in brackets [].

This document has **12** pages. Any blank pages are indicated.

- 1 A student investigates the period of a pendulum. Fig. 1.1 and Fig. 1.2 show the set-up.

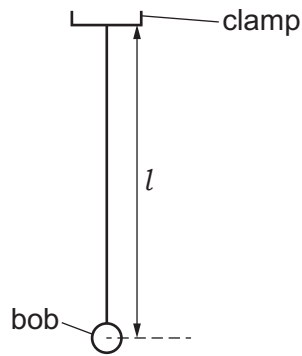

Fig. 1.1

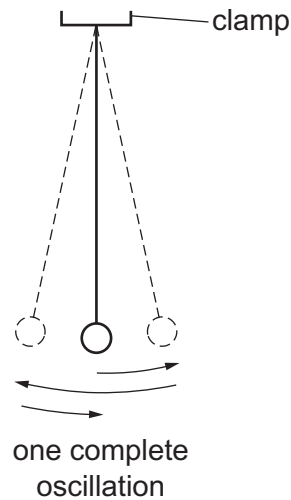

Fig. 1.2

- (a) Explain briefly how to measure to the centre of the pendulum bob as accurately as possible.

.....
 [1]

- (b) The student adjusts the length of the pendulum until the distance l , measured from the bottom of the clamp supporting the pendulum to the centre of the pendulum bob, is 50.0 cm.

He displaces the bob slightly and releases it so that it swings. Fig. 1.2 shows one complete oscillation of the pendulum.

He measures and records the time t for 20 complete oscillations.

- (i) Calculate, and record in Table 1.1, the period T of the pendulum. The period is the time for one complete oscillation. [1]
- (ii) Calculate, and record in Table 1.1, the value of T^2 . [1]

Table 1.1

l/cm	t/s	T/s	T^2/s^2
50.0	28.2		
60.0	31.2	1.56	2.43
70.0	33.6	1.68	2.82
80.0	35.8	1.79	3.20
90.0	38.2	1.91	3.65

He repeats the procedure using l values of 60.0 cm, 70.0 cm, 80.0 cm and 90.0 cm. The readings and results are shown in Table 1.1.

- (c) Plot a graph of T^2/s^2 (y-axis) against l/cm (x-axis). Start the T^2/s^2 axis at a convenient value close to the minimum value of T^2/s^2 .

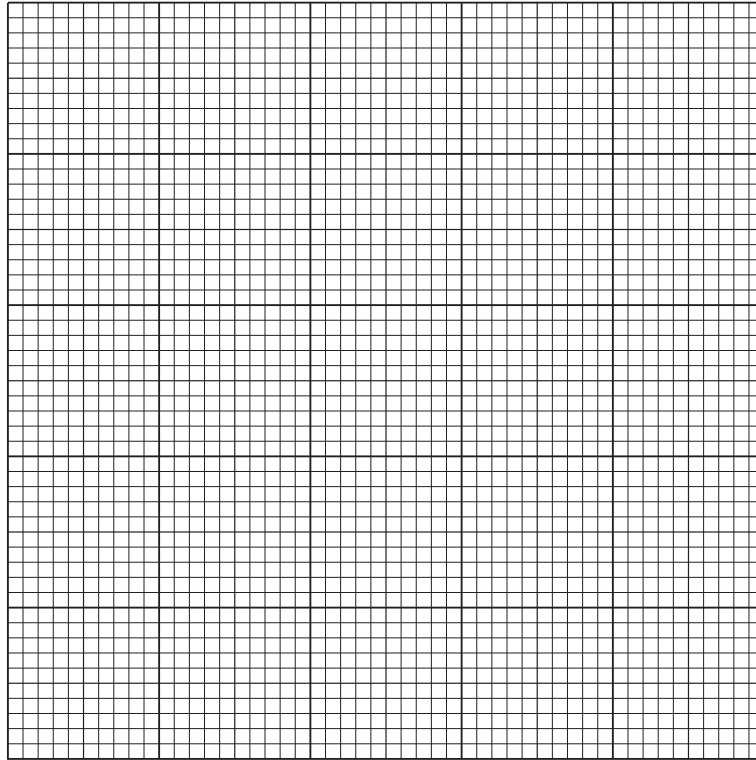

[4]

- (d) Determine the gradient G of the graph. Show clearly on the graph how you obtained the necessary information.

$G = \dots\dots\dots$ [3]

- (e) Explain briefly why timing 20 oscillations gives a more accurate result for the period T than timing 1 oscillation.

.....

..... [1]

[Total: 11]

2 A student investigates the resistance of a lamp. She uses the circuit shown in Fig. 2.1.

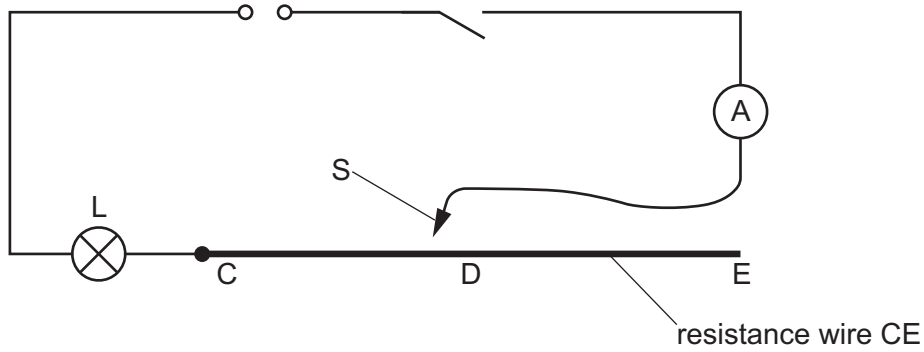

Fig. 2.1

- (a) On Fig. 2.1, draw a voltmeter connected to measure the potential difference (p.d.) across the lamp. [1]
- (b) The student places a sliding contact S on the resistance wire CE as close as possible to point C.

She measures the potential difference V_1 across lamp L and the current I_1 in the circuit. The readings are shown in Fig. 2.2 and Fig. 2.3.

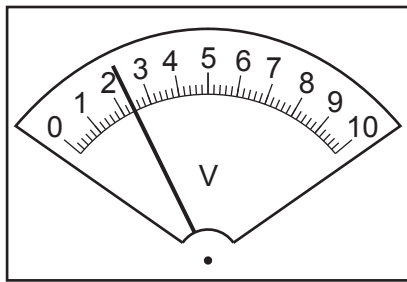

Fig. 2.2

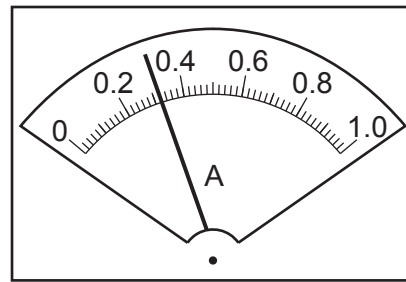

Fig. 2.3

- (i) Record the readings shown in Fig. 2.2 and Fig. 2.3.

$V_1 = \dots\dots\dots$ V

$I_1 = \dots\dots\dots$ A [2]

- (ii) Calculate the resistance R_1 of lamp L. Use the equation $R_1 = \frac{V_1}{I_1}$. Include the unit.

$R_1 = \dots\dots\dots$ [1]

- (c) She places the sliding contact S on the resistance wire as close as possible to point D. Point D is at the mid-point of the resistance wire.

She measures the potential difference V_2 across lamp L.

$V_2 = \dots\dots\dots 1.4 \dots\dots\dots$ V

She measures the current I_2 in the circuit.

$$I_2 = \dots\dots\dots 0.24 \dots\dots\dots \text{A}$$

Calculate the resistance R_2 of lamp L. Use the equation $R_2 = \frac{V_2}{I_2}$. Include the unit. Give your answer to a suitable number of significant figures for this experiment.

$$R_2 = \dots\dots\dots [1]$$

- (d) She places the sliding contact S on the resistance wire as close as possible to point E.

She measures the potential difference V_3 across lamp L.

$$V_3 = \dots\dots\dots 0.9 \dots\dots\dots \text{V}$$

She measures the current I_3 in the circuit.

$$I_3 = \dots\dots\dots 0.18 \dots\dots\dots \text{A}$$

Calculate the resistance R_3 of lamp L. Use the equation $R_3 = \frac{V_3}{I_3}$. Include the unit.

$$R_3 = \dots\dots\dots [1]$$

- (e) Complete the following statements, referring to your practical experience and the results.

- As the length of resistance wire included in the circuit is increased, the brightness of the lamp
- As the length of resistance wire included in the circuit is increased, the resistance of the lamp

[2]

- (f) A variable resistor can be used in this type of experiment in place of the resistance wire.

Draw a circuit diagram to show a variable resistor in place of the resistance wire. Include the ammeter and the voltmeter in your diagram.

[3]

[Total: 11]

[Turn over

- 3 A student investigates the effect of the starting temperature on the cooling rate of water.

Fig. 3.1 shows the apparatus used.

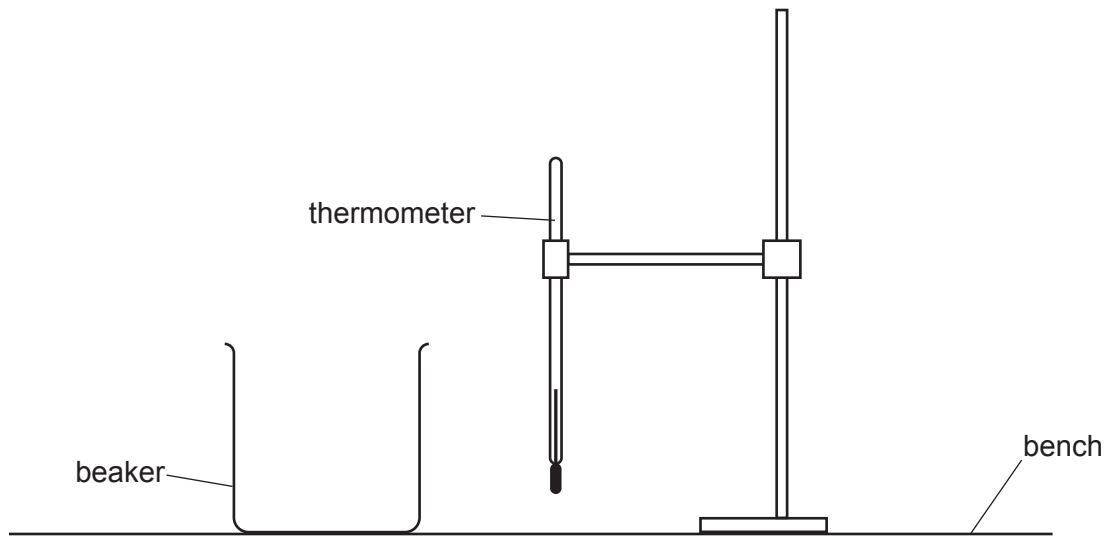

Fig. 3.1

- (a) The thermometer in Fig. 3.2 shows the room temperature θ_R at the beginning of the experiment. Record θ_R .

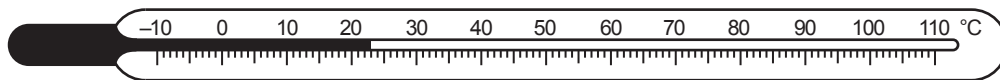

Fig. 3.2

$$\theta_R = \dots\dots\dots^\circ\text{C} \quad [1]$$

- (b) The student uses a measuring cylinder to pour 200 cm^3 of hot water into the beaker.

He records in Table 3.1 the temperature θ of the hot water at time $t = 0$.

He measures, and records in Table 3.1, the water temperature every 30 s.

Complete the time t column in Table 3.1.

[1]

Table 3.1

t/s	$\theta/^\circ\text{C}$
0	88
	82
	78
	74
	71
	69
	67

- (c) Calculate the decrease in temperature $\Delta\theta_1$ between $t = 0$ and $t = 180$ s.

$$\Delta\theta_1 = \dots\dots\dots$$

Calculate the average rate of cooling C_1 of the water using the equation $C_1 = \frac{\Delta\theta_1}{\Delta t}$, where $\Delta t = 180$ s. Include the unit.

$$C_1 = \dots\dots\dots [2]$$

- (d) The student empties the beaker.

He pours warm water into the same beaker.

He records in Table 3.2 the temperature θ of the warm water at time $t = 0$.

He measures, and records in Table 3.2, the water temperature every 30 s.

Table 3.2

t/s	$\theta/^\circ\text{C}$
0	74
30	71
60	70
90	68

Using Table 3.2, calculate the decrease in temperature $\Delta\theta_2$ between $t = 0$ and $t = 90$ s.

$$\Delta\theta_2 = \dots\dots\dots$$

Calculate the average rate of cooling C_2 of the water using the equation $C_2 = \frac{\Delta\theta_2}{\Delta t}$, where $\Delta t = 90$ s.

$$C_2 = \dots\dots\dots [1]$$

- (e) A student suggests that the rate of cooling of water depends on the initial temperature of the water.

Write a conclusion about the effect of the initial temperature of water on the rate of cooling of the water, based on the results. Justify your conclusion by reference to values from the results.

conclusion

.....

justification

.....

[2]

(f) State **two** requirements when reading the volume of water in a measuring cylinder in order to obtain an accurate result.

1.

2.

[2]

(g) Suggest **two** possible variables that the student should keep constant.

1.

2.

[2]

[Total: 11]

BLANK PAGE

- 4 A student investigates the horizontal distance travelled by a metal ball after it rolls off the end of a plastic track. Fig. 4.1 shows the set-up.

The ball rolls down a plastic track. The left-hand side of the track is fixed. The right-hand side can be adjusted so that the ball comes off the track at different angles.

The student measures the horizontal distance that the ball travels from the right-hand end of the track to the point that it hits the floor.

Plan an experiment to investigate how the horizontal distance travelled by the metal ball depends on the angle that the right-hand end of the track makes with the bench.

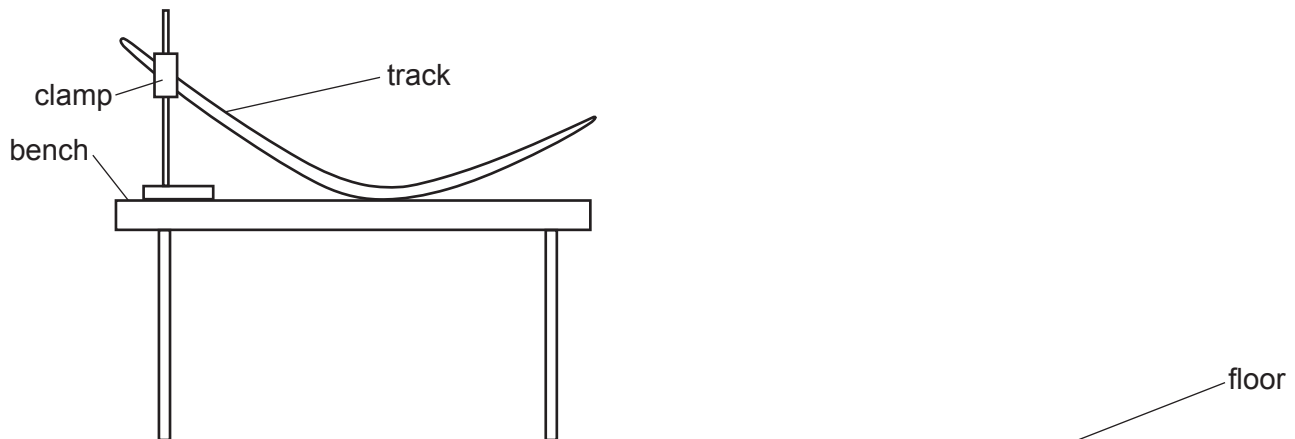

Fig. 4.1

The following apparatus is available to the student:

- track with stand, boss and clamp
- selection of metal balls.

Other apparatus normally available in a school laboratory can also be used.

In your plan, you should:

- list any additional apparatus required
- explain briefly how you would do the investigation, including the measurements you would take
- state the key variables to be kept constant
- draw a suitable table, with column headings, to show how you would display your readings (you are **not** required to enter any readings in the table)
- explain how you would use the results to reach a conclusion.

BLANK PAGE

Permission to reproduce items where third-party owned material protected by copyright is included has been sought and cleared where possible. Every reasonable effort has been made by the publisher (UCLES) to trace copyright holders, but if any items requiring clearance have unwittingly been included, the publisher will be pleased to make amends at the earliest possible opportunity.

To avoid the issue of disclosure of answer-related information to candidates, all copyright acknowledgements are reproduced online in the Cambridge Assessment International Education Copyright Acknowledgements Booklet. This is produced for each series of examinations and is freely available to download at www.cambridgeinternational.org after the live examination series.

Cambridge Assessment International Education is part of Cambridge Assessment. Cambridge Assessment is the brand name of the University of Cambridge Local Examinations Syndicate (UCLES), which is a department of the University of Cambridge.