

Please write clearly in block capitals.

Centre number

Candidate number

Surname _____

Forename(s) _____

Candidate signature _____

I declare this is my own work.

INTERNATIONAL AS PHYSICS

Unit 1 Mechanics, materials and atoms

Tuesday 14 January 2020

07:00 GMT

Time allowed: 2 hours

Materials

For this paper you must have:

- a Data and Formulae Booklet as a loose insert
- a ruler with millimetre measurements
- a scientific calculator, which you are expected to use where appropriate.

Instructions

- Use black ink or black ball-point pen.
- Fill in the boxes at the top of this page.
- Answer **all** questions.
- You must answer the questions in the spaces provided. Do not write outside the box around each page or on blank pages.
- All working must be shown.
- If you need extra space for your answer(s), use the lined pages at the end of this book. Write the question number against your answer(s).
- Do all rough work in this book. Cross through any work you do not want to be marked.

Information

- The marks for questions are shown in brackets.
- The maximum mark for this paper is 80.

For Examiner's Use	
Question	Mark
1	
2	
3	
4	
5	
6	
7	
8	
9	
10–23	
TOTAL	



Section A

Answer **all** questions in this section.

0 1

A ruler is used to measure the width of a desk.

Describe **one** random error and **one** systematic error that could occur when making this measurement.

[2 marks]

random error _____

systematic error _____

2

0 2

An electron is produced during pair production.

Describe what happens in the pair-production event.

[3 marks]

3



0 3 . 1

Alpha particles were directed towards a thin gold foil in the Rutherford scattering experiment.

Describe the paths of the alpha particles.

[3 marks]

0 3 . 2

The Rutherford scattering experiment was responsible for a change in the understanding of the structure of atoms.

Describe how Rutherford's model of the atom differed from the previous model.

[2 marks]

5

Turn over ►



0 4

A nucleus of molybdenum decays by β^- emission to produce technetium-99m as shown in the equation.

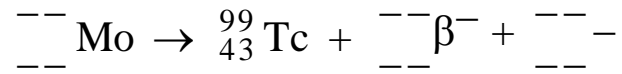

0 4 . 1

Complete the decay equation.

[3 marks]

0 4 . 2

Technetium-99m emits gamma radiation.

State the effect on the technetium-99m nucleus of the emission of a gamma ray.

[1 mark]



0 4 . 3

A detector is placed near a source of technetium-99m.
Figure 1 shows the variation with time of the measured count rate.

Figure 1

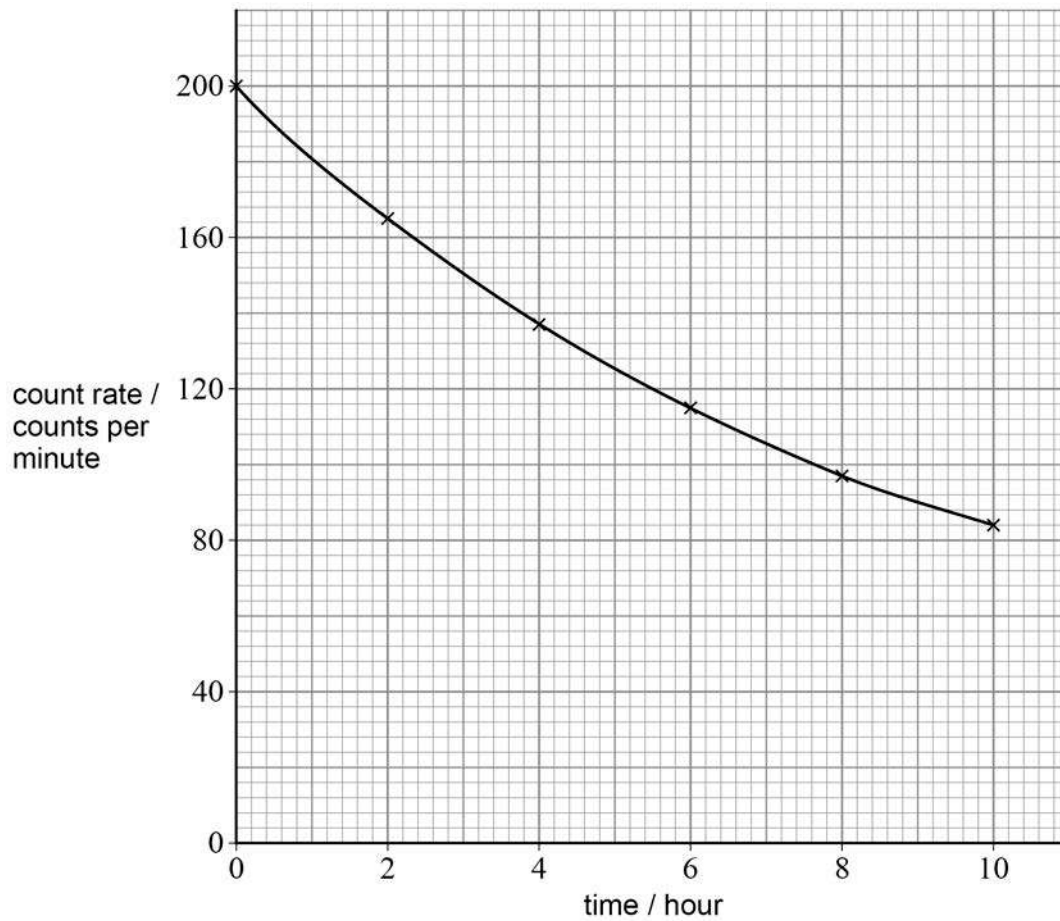

The background count rate is 30 counts per minute.

Determine the half-life of technetium-99m.

[3 marks]

half-life = _____ hour

7

Turn over ►



0 5

A car is pulled along a horizontal road towards a stationary lorry. The car is pulled by a wire attached to an electric motor as shown in **Figure 2**.

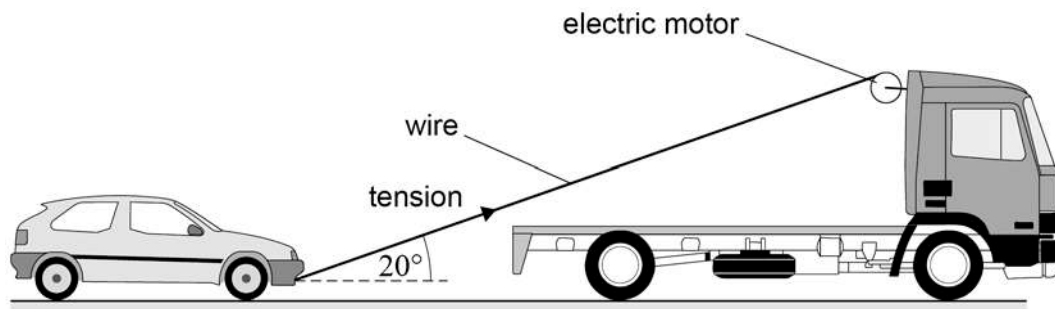
Figure 2

At the instant shown in **Figure 2**, the power transferred by the electric motor to the car is 300 W.

The wire makes an angle of 20° to the horizontal.

The resistive forces acting on the car are constant throughout this question.

0 5 . 1

The car moves at a steady speed of 0.60 m s^{-1} .

Calculate the tension in the wire when the car is in the position shown in **Figure 2**.

[2 marks]

tension = _____ N



0 5 . 2 The motor has an efficiency of 87%.

Calculate the electrical power input to the motor.

[2 marks]

electrical power input = _____ W

0 5 . 3 The car is then pulled up a ramp as shown in **Figure 3**.

Figure 3

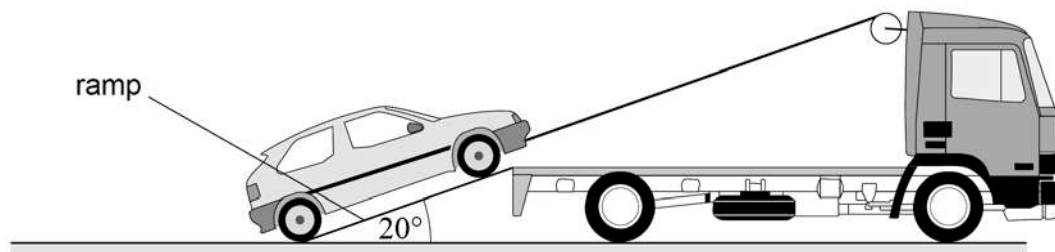

The car is pulled up the ramp at a speed of 0.60 m s^{-1} .
The ramp and the wire both make an angle of 20° to the horizontal.

Explain why the power transferred by the electric motor to the car must be greater than 300 W.

[2 marks]

Question 5 continues on the next page

Turn over ►



0 5 . 4

The car is pulled along the horizontal lorry bed as shown in **Figure 4**. The tension in the wire remains constant as the car moves along the lorry bed.

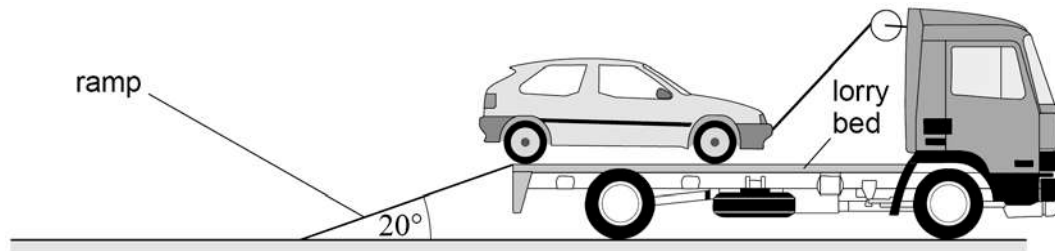
Figure 4

State and explain what will happen to the speed of the car as it is pulled along the lorry bed.

[2 marks]

8



0 6 . 1

Explain the difference between speed and velocity.

[2 marks]

Question 6 continues on the next page**Turn over ►**

When an insect jumps, it achieves a maximum height of 0.18 m and travels a horizontal distance of 0.32 m as shown in **Figure 5**. Air resistance is negligible.

Figure 5

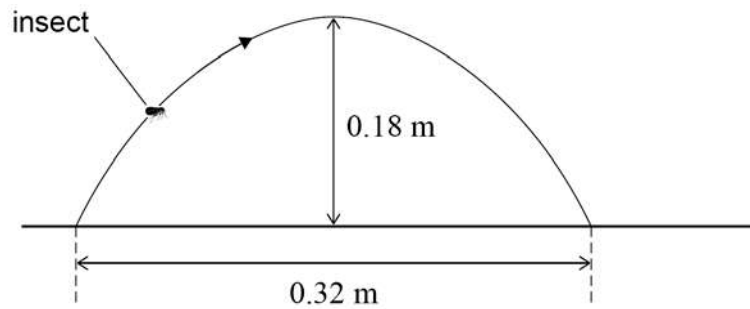

0 6 . 2 Show that the initial vertical component of velocity of the insect is approximately 1.9 m s^{-1} .

[2 marks]

0 6 . 3 Show that the insect is in the air for approximately 0.4 s.

[3 marks]



0 6 . 4

State the position of the insect when it has its minimum speed during the jump.
Explain your answer.

[2 marks]

0 6 . 5

Show that the minimum speed of the insect during the jump is approximately 0.8 m s^{-1} .

[1 mark]

0 6 . 6

Determine the initial velocity of the insect.

[4 marks]

initial velocity = _____ m s^{-1}

direction _____

14

Turn over ►

0 7

A climber **P** is connected to another person on the ground by a climbing rope as shown in **Figure 6**.
The rope runs over a frictionless pulley attached to the wall at **R**.

Figure 6



P falls and gravitational potential energy is transferred to work done in stretching the rope. The work done in stretching the rope is 5.3 kJ.

P is stationary for an instant at the end of the fall.

P has a mass of 80 kg.

0 7 . 1

Calculate the height through which **P** falls.

[2 marks]

height = _____ m



0 7 . 2 The climbing rope stretches by 1.6 m as **P** falls. The rope obeys Hooke's law.

Show that the stiffness k of the rope is approximately 4.0 kN m^{-1} .

[2 marks]

0 7 . 3 Calculate the tension in the rope when **P** is at the lowest position.

[1 mark]

tension = _____ N

Question 7 continues on the next page

Turn over ►



07.4

After being brought to rest, **P** begins to accelerate upwards due to the tension in the rope.

Calculate the initial upward acceleration of **P**.

[3 marks]

acceleration = _____ m s^{-2}

07.5

The pulley at **R** is replaced with one that has a significant amount of friction.

Deduce how your answer to Question **07.4** would be different.

[3 marks]

11**END OF SECTION A**

Turn over for Section B

*Do not write
outside the
box*

**DO NOT WRITE ON THIS PAGE
ANSWER IN THE SPACES PROVIDED**

Turn over ►



Section BAnswer **all** questions in this section.**0 8**

Figure 7 shows some of the apparatus used in an experiment to investigate how air resistance varies with speed. The air resistance is equal to the weight of a falling object when the object is at its terminal speed.

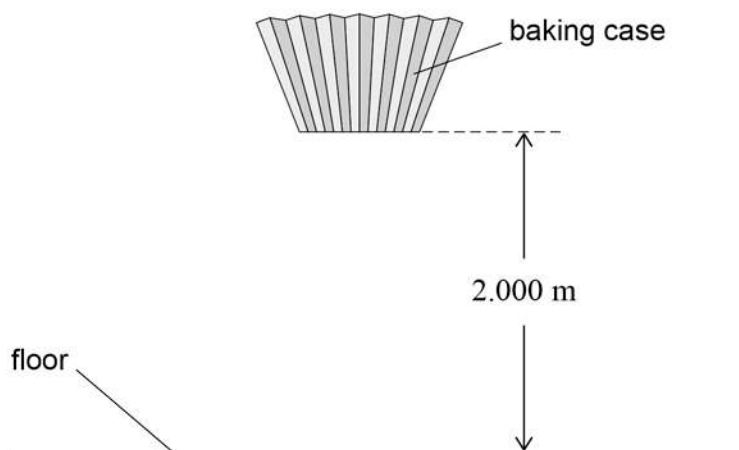
Figure 7

A small weight was placed in a baking case, giving a total weight w of 0.050 N. The baking case was dropped from a height of 2.000 m onto the floor. The time t for the baking case to fall this distance was measured.

Assume that the baking case fell at terminal speed v throughout the fall. The experiment was performed six times to find the mean time T for the fall.



08.1 Table 1 shows the results when w was 0.050 N.

Table 1

t/s	0.65	0.69	0.71	0.68	0.69	0.66
-------	------	------	------	------	------	------

The mean time $T = 0.68$ s.

State the absolute uncertainty in T .

[1 mark]

absolute uncertainty in $T =$ _____ s

08.2 Calculate v when $w = 0.050$ N.

[1 mark]

$v =$ _____ m s^{-1}

08.3 The uncertainty in the measurement of height is negligible.

Calculate the absolute uncertainty in your answer to Question **08.2**.

[2 marks]

absolute uncertainty in $v =$ _____ m s^{-1}

Question 8 continues on the next page

Turn over ►



0 8 . 4

The experiment was then repeated with different weights placed in the baking case. For each weight the terminal speed v was calculated. The data are plotted on **Figure 8**.

Plot on **Figure 8** the data point for $w = 0.050$ N with its error bar.
Draw a line of best fit.

[2 marks]

Figure 8

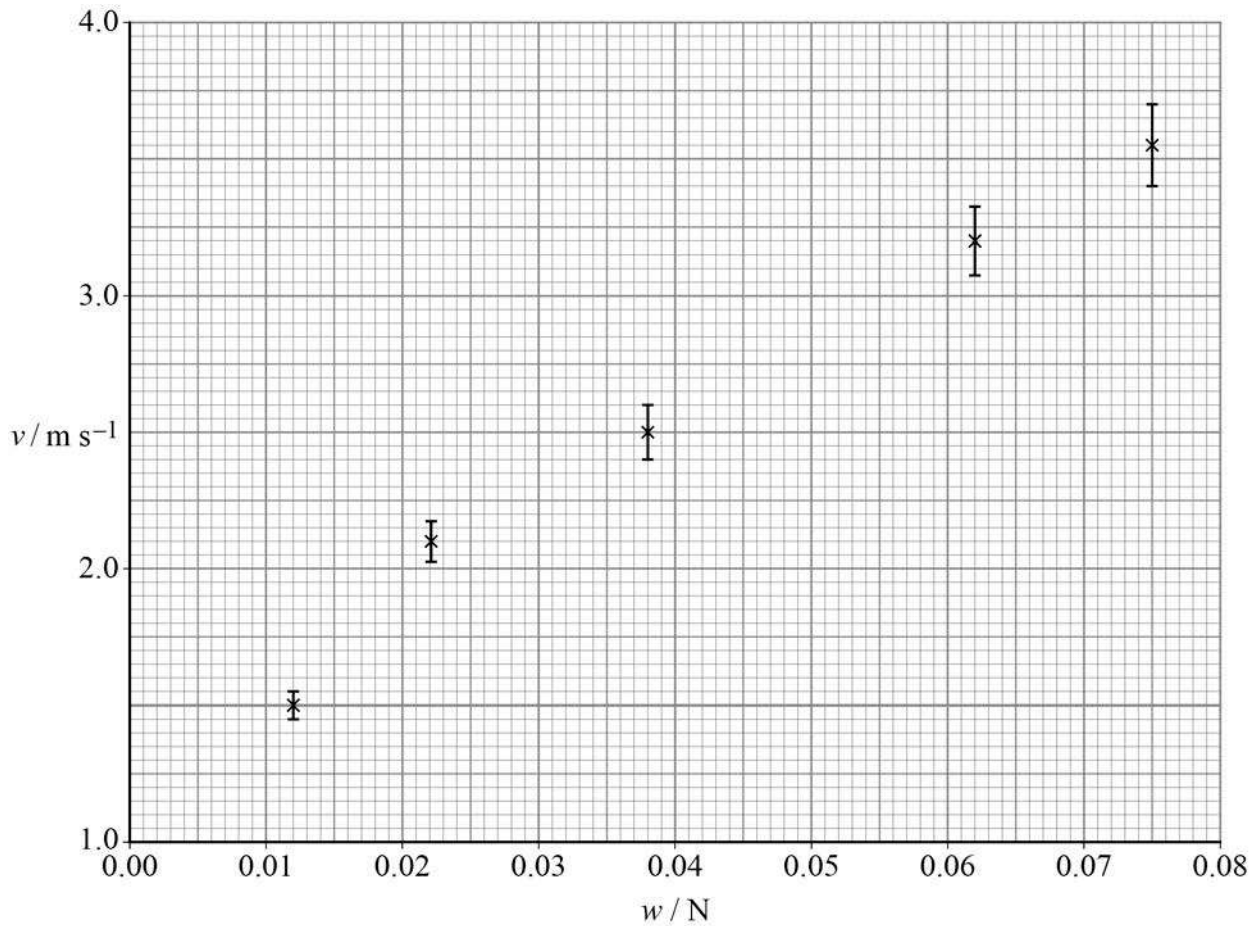

0 8 . 5

It is suggested that, for a falling object, the force F acting on it due to air resistance is related to the instantaneous speed u of the object by

$$F \propto u^2$$

Explain how the results from this experiment could be used to test this suggestion.

[2 marks]

8

Turn over for the next question

Turn over ►



0 9 . 1 State what is meant by impulse.

[1 mark]

Sand falls vertically at a constant rate of $372 \text{ m}^3 \text{ min}^{-1}$ onto a horizontal conveyor belt as shown in **Figure 9**. The horizontal speed of the belt is 7.8 m s^{-1} .

Figure 9

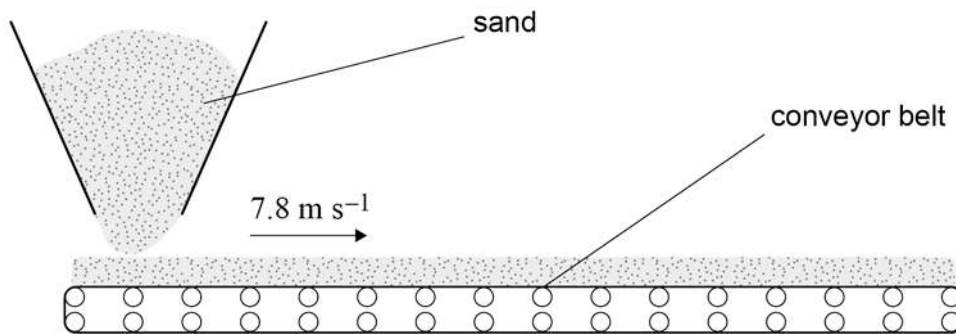

0 9 . 2 The belt accelerates the sand to a speed of 7.8 m s^{-1} . The sand does not slip.

Show that the average horizontal force exerted by the belt on the sand is approximately $1.2 \times 10^5 \text{ N}$.

density of sand = 2500 kg m^{-3}

[3 marks]



0 9 . 3

The conveyor belt is driven by a motor continuously for a period of 24 hours.
Friction in the belt system is 4.5×10^5 N.

Calculate the total energy transferred by the motor.

[3 marks]

total energy transferred = _____ J

0 9 . 4

As the sand lands on the belt, its horizontal component of momentum changes.

Explain how this change is consistent with the law of conservation of momentum.

[1 mark]

8

END OF SECTION B

Turn over ►



Section C

Each of the questions in this section is followed by four responses, **A**, **B**, **C** and **D**.

For each question select the best response.

Only **one** answer per question is allowed.

For each question, completely fill in the circle alongside the appropriate answer.

CORRECT METHOD



WRONG METHODS



If you want to change your answer you must cross out your original answer as shown.



If you wish to return to an answer previously crossed out, ring the answer you now wish to select as shown.



You may do your working in the blank space around each question but this will not be marked.
Do **not** use additional sheets for this working.

1 0 The graph shows the variation of y with x .

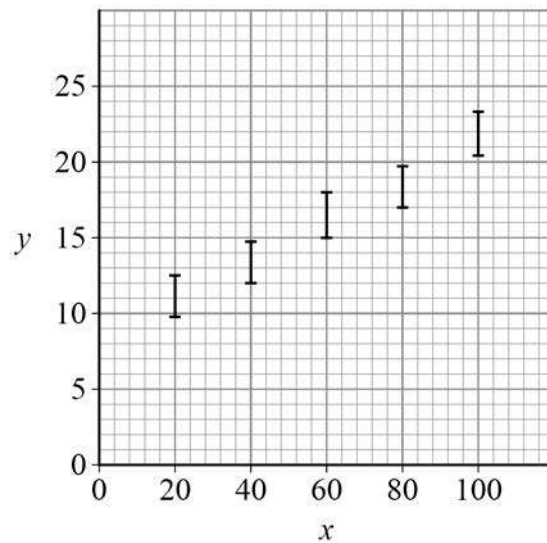

What is the best value of the intercept on the y axis?

[1 mark]

A 7

B 8

C 10

D 11



1 1 A body in total equilibrium **must**

[1 mark]

- A** be travelling at a constant speed in a straight line.
- B** be at rest.
- C** have zero resultant force acting upon it.
- D** have no couple acting upon it.

1 2 A uniform bar of mass 1.3 kg is attached to a vertical wall and supported by a string. The string makes an angle of 40° to the vertical.

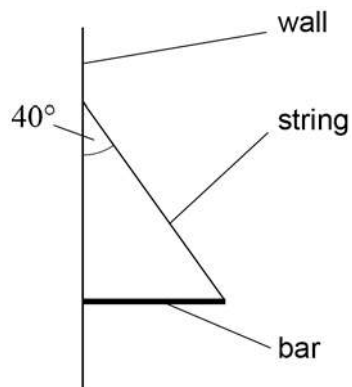

What is the tension in the string?

[1 mark]

- A** 8.3 N
- B** 9.9 N
- C** 16.6 N
- D** 19.8 N

Turn over ►



1 3

An athlete runs at a constant speed of 5.0 m s^{-1} for 140 s around a circular track of circumference 200 m.

What is the magnitude of the athlete's final displacement from her starting point?

[1 mark]

- A** 32 m
- B** 45 m
- C** 64 m
- D** 100 m

1 4

The graph shows the variation of speed v with time t for an object.

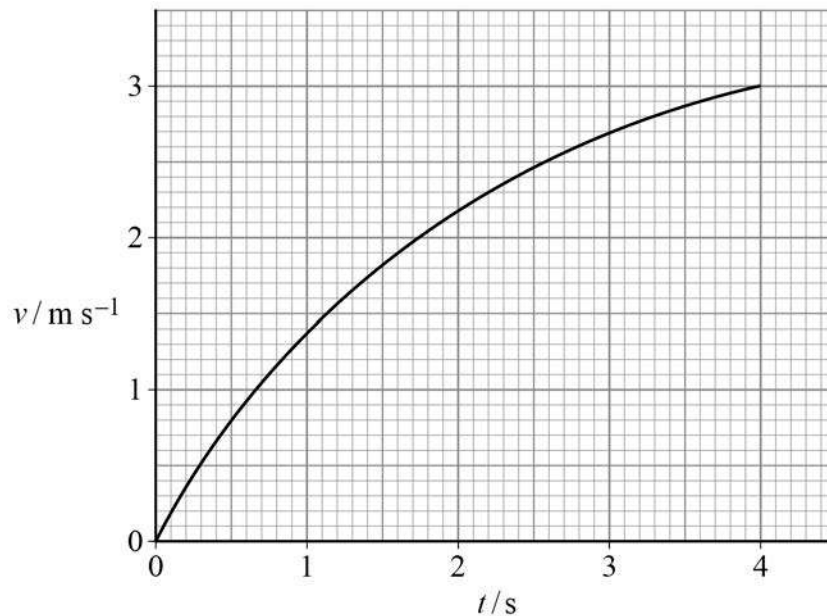

What are the initial acceleration and the total distance travelled for the object?

[1 mark]

	Initial acceleration / m s^{-2}	Total distance travelled / m	
A	0.75	6.0	<input type="radio"/>
B	0.75	7.5	<input type="radio"/>
C	2	6.0	<input type="radio"/>
D	2	7.5	<input type="radio"/>



1 5

Which statement is **always** correct?

[1 mark]

- A Brittle fracture occurs with little or no elastic extension.
- B Brittle fracture occurs with little or no plastic extension.
- C In plastic behaviour, stress is proportional to strain.
- D In elastic behaviour, stress is proportional to strain.

1 6

An object of weight W rests on a horizontal table. The normal reaction force of the table on the object is R .

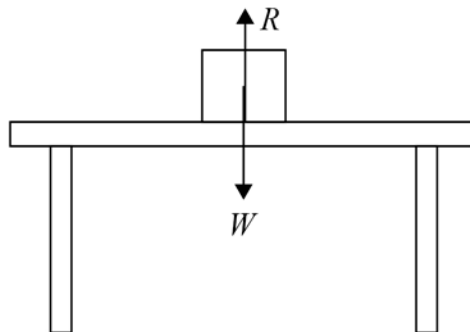
Which statement is **not** true?

[1 mark]

- A W and R are equal in magnitude.
- B The object is in equilibrium.
- C W and R are an action-reaction pair.
- D R is a contact force.

Turn over ►



1 7

A dart of mass m hits a target with velocity v . The point of the dart penetrates a distance d into the target.

Assume that the deceleration of the dart is uniform.

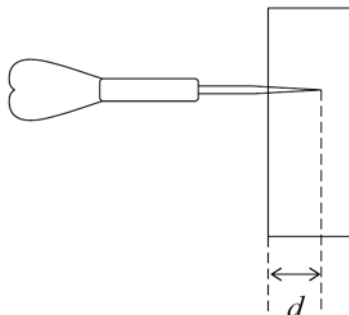

The time taken for the dart to penetrate the distance d is

[1 mark]

A $\frac{d}{v}$

B $\frac{2d}{v}$

C $\frac{dm}{v}$

D $\frac{2dm}{v}$

1 8

Which list shows the particles in increasing order of their specific charges?

[1 mark]

A positron, ${}^4_2\text{He}$ nucleus, ${}^1_1\text{H}$ nucleus

B neutron, ${}^4_2\text{He}$ nucleus, positron

C ${}^1_1\text{H}$ nucleus, ${}^4_2\text{He}$ nucleus, neutron

D proton, ${}^4_2\text{He}$ nucleus, neutron



1 9

A steel ball of mass m is placed against a spring that is compressed by a distance ΔL . The ball is released so that it is projected along a smooth table top.

The spring constant is k .

The maximum speed of the steel ball is v .

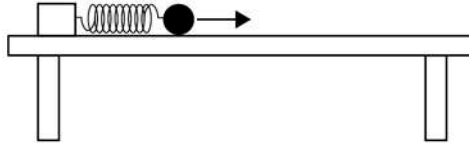

The process is repeated with a spring of spring constant $3k$ and a second steel ball of mass $2m$. The spring is compressed by a distance ΔL .

The maximum speed of the second ball is

[1 mark]

A $\frac{\sqrt{2}}{3}v$

B $\sqrt{\frac{2}{3}}v$

C $\frac{2}{\sqrt{3}}v$

D $\sqrt{\frac{3}{2}}v$

Turn over for the next question

Turn over ►



2 0

A wire made of two sections **P** and **Q** is suspended from a support.
A force is applied to the end of the wire.

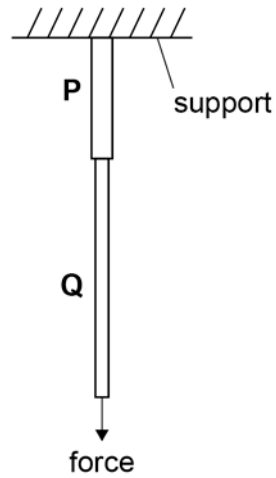

The table shows data for **P** and **Q**.

Property	P	Q
Young modulus	E	$3E$
Initial length	L	$2L$
Cross-sectional area	A	$\frac{A}{2}$
Extension	ΔL	

The **total** extension of the wire is

[1 mark]

A $\frac{2}{3}\Delta L$

B $\frac{4}{3}\Delta L$

C $\frac{5}{3}\Delta L$

D $\frac{7}{3}\Delta L$



2 1 \bar{X} is the antiparticle of X .

Which properties are the same for X and \bar{X} ?

[1 mark]

- A** mass and magnitude of charge only
- B** mass and rest energy only
- C** rest energy and magnitude of charge only
- D** mass, magnitude of charge and rest energy

2 2 A detector is placed 20 cm from a radioactive source in air. The corrected count rate is 50 counts per second.

A 4 mm aluminium absorber is placed between the source and the detector. The corrected count rate then falls to 10 counts per second.

The emissions from the source could be

[1 mark]

- A** α , β^- and γ .
- B** α and β^- only.
- C** α and γ only.
- D** β^- only.

2 3 A radioactive isotope has a half-life of 8 years. The initial activity of the sample is 89 MBq.

After what time will the activity have fallen to 0.50 MBq?

[1 mark]

- A** between 40 years and 48 years
- B** between 48 years and 56 years
- C** between 56 years and 64 years
- D** between 64 years and 72 years

END OF QUESTIONS



There are no questions printed on this page

*Do not write
outside the
box*

**DO NOT WRITE ON THIS PAGE
ANSWER IN THE SPACES PROVIDED**



